

ACCESSORIES CONT. - INSTANTTABLE

LEAF KIT

Bridge two tables together to create more table space.



LEAF SHELF KIT

Add shelves to the leaf expansion section for more space.



TABLE CONNECTION KIT

Connecting tables is a snap with the table connection kit.



ADDITIONAL ACCESSORIES

- Table Covers
- Hard Panel Skirts
- Table Wraps
- Solid Table Top Inserts
- Wheel Casters

OM.IT.1106

ACCESSORIES CONT. - INSTANTTABLE

TABLE CONFIGURATIONS

Go modular. Connect and stack multiple tables together in various combinations. Create your own configuration.



E-Z UP  **WARRANTY**

INTERNATIONAL E-Z UP, INC., manufacturer of the E-Z UP® Instant Table System™, warrants to the original purchaser who provides a dated sales receipt, each part to be free from defects in material or workmanship for a period of two years after the date of original purchase. This warranty applies only for normal and expected uses, as determined by the manufacturer.

www.ezup.com

We Make Life E-ZI!™
INTERNATIONAL E-Z UP, INC.
Professional Products Division
1601 Iowa Avenue, Riverside, California 92507
(951) 781-0843 • Fax (951) 781-0856

OWNER'S MANUAL

InstantTable™

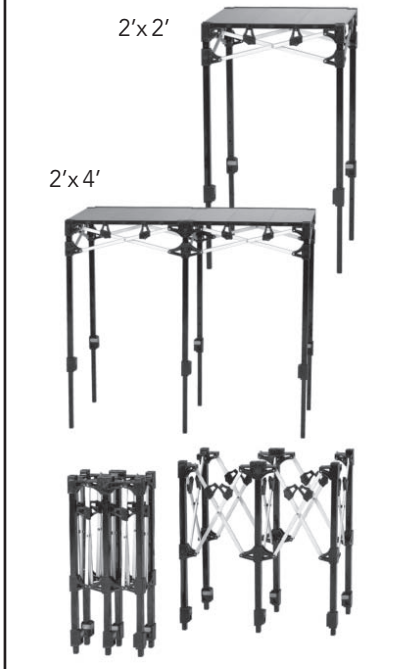

2x2 BOX INCLUDES:

- (1) InstantTable™ 2'x2' Frame
- (1) InstantTable™ Folding Panels
- (1) Deluxe InstantTable™ Storage Case
- (4) Soft Surface Foot Pads

2x4 BOX INCLUDES:

- (1) InstantTable™ 2'x4' Frame
- (2) InstantTable™ Folding Panels
- (1) Deluxe InstantTable™ Storage Case
- (6) Soft Surface Foot Pads



Customer Service Hot Line
(800) 45 SHADE
www.ezup.com

2'X2' INSTANTTABLE

HOW TO SET UP 2x2

1. Grasp top corner caps and expand frame. Place one hand on top of the corner cap and raise the corner toggle slider to lock into place. Lock opposite corner toggle. **Be careful not to pinch fingers.**

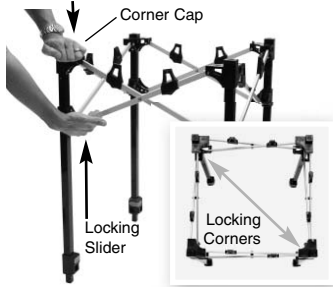

2. Set table height. Tilt table and press height adjustment toggle to set desired height. Leg will lock into one of three fixed height settings.



3. Open folding panels. Locate indexing hole and align with pins located on the center and corner top caps. Place folding panels on frame.

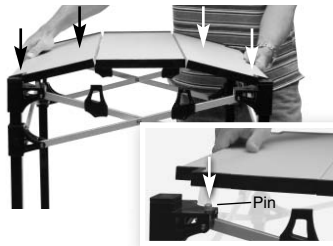

HOW TO TAKE DOWN 2x2

1. Remove folding panels and lower legs.

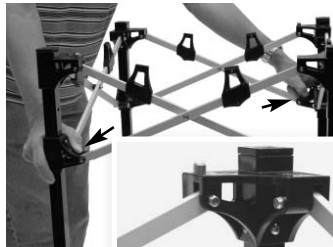

2. Unlock sliders by pressing corner toggle buttons simultaneously and pull down slightly. From one corner tilt table and pull toggle down away from top corner cap.



3. Grasp corner top caps and pull together to close.

Note: When storing folding panels, fold short hinges first followed by longer hinges.

2'X4' INSTANTTABLE

HOW TO SET UP 2x4

1. Grasp corner top caps and pull apart slightly. From middle leg position, grasp adjacent corners and expand frame. Lift on middle toggle slider and raise to lock into place. **Be careful not to pinch fingers.**

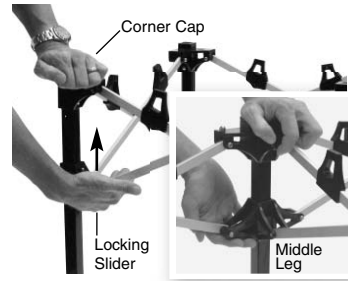

2. Set table height. Tilt table and press height adjustment toggle to set desired height. Leg will lock into one of three fixed height settings.

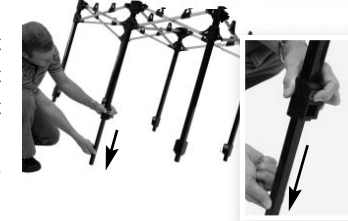

3. Open folding panels. Locate indexing hole and align with pins located on the center and corner top caps. Place top on frame and repeat on second side.

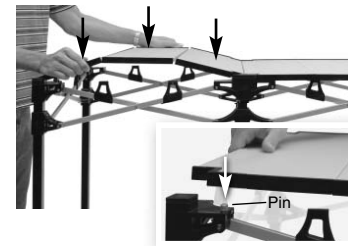

HOW TO TAKE DOWN 2x4

1. Remove folding panels and lower legs.

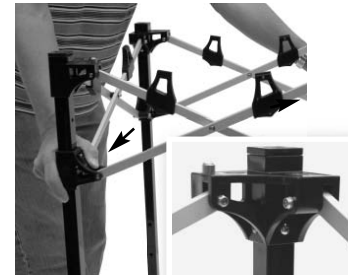

Note: Lower center legs first (stabilize table while lowering).

2. Unlock sliders by pressing corner toggle buttons simultaneously and pull down slightly. Grasp middle top cap and middle toggle slider and pull apart approximately 1/2 its size.



TAKE DOWN 2x4 CONT.

3. Grasp corner top caps and pull together to close.

Note: When storing folding panels, fold short hinges first followed by longer hinges.

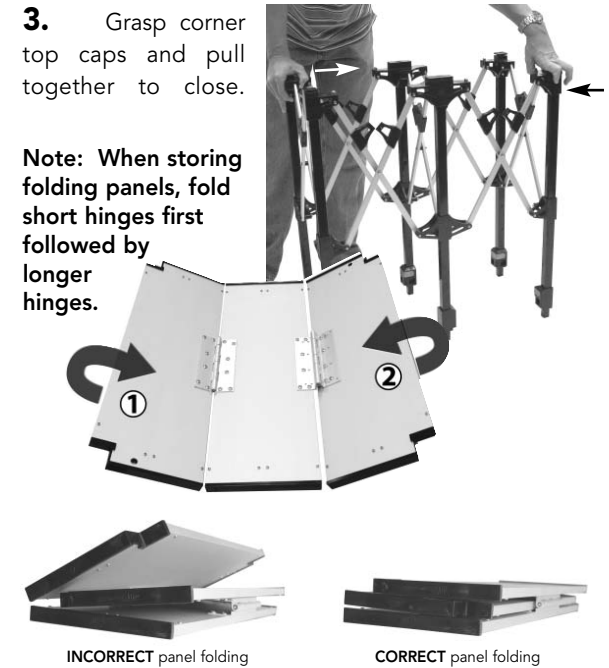

ACCESSORIES - INSTANTTABLE

Customize the InstantTable™ and change your display at any time with various accessory options.

SHELF KIT

Accessorize the table with adjustable shelves and add additional storage space.

Note: Shown with included soft surface foot pads installed.

